



Loudspeaker System



XR200 Owner's Manual



WARNING - TO REDUCE RISK OF FIRE OR ELECTRICAL SHOCK, DO NOT EXPOSE THIS EQUIPMENT TO RAIN OR MOISTURE.

NO USER-SERVICEABLE PARTS INSIDE. REFER SERVICING TO QUALIFIED PERSONNEL.

To prevent the risk of electric shock, do not remove cover or back. No user-serviceable parts inside.

IMPORTANT SAFETY INSTRUCTIONS!

PLEASE READ THEM BEFORE OPERATING THIS EQUIPMENT.

1. Read these instructions.
2. Keep these instructions.
3. Heed all warnings.
4. Follow all instructions.
5. Do not use this apparatus near water.
6. Clean only with a non-abrasive dry soft cloth.
7. Install in accordance with the manufacturer's instructions.
8. **This Loudspeaker is capable of producing extremely high sound pressure levels, even when connected to amplifiers of moderate power output. User caution is advised. Ear protection is recommended when playing at high volumes as continued exposure to high sound pressure levels can cause permanent hearing impairment or loss. The use of a Sound Level Pressure Meter will greatly aid in determining when high volume levels are occurring.**
9. Do not install near any heat sources such as radiators, heat registers, stoves, or other apparatus (including amplifiers) that produce heat.
10. Only use attachments/accessories specified by the manufacturer.
11. Use only with the cart, stand, tripod, bracket, or table specified by the manufacturer, or sold with the apparatus. When a cart is used, use caution when moving the cart/apparatus combination to avoid injury from tip-over. 
12. Refer all servicing to qualified service personnel. Servicing is required when the apparatus has been damaged in any way, liquid has been spilled or objects have fallen into the apparatus, the apparatus has been exposed to rain or moisture, does not operate normally, or has been dropped.
13. Do not expose this equipment to dripping or splashing and ensure that no objects filled with liquids, such as vases, are placed on the equipment.
14. **WARNING: When this Loudspeaker is connected to an amplifier that is Powered On, the connection terminals may have hazardous live voltages present with a risk of electric shock.**
15. **CAUTION: This Loudspeaker weighs 113 pounds (51.3 kgs). It requires two or more persons to safely move the Loudspeaker.**

Thank You

Your decision to own this McIntosh XR200 Loudspeaker System ranks you at the very top among discriminating music listeners. You now have “The Best.” The McIntosh dedication to “Quality,” is assurance that you will receive many years of listening enjoyment from this unit. Please take a short time to read the information in this manual. We want you to be as familiar as possible with all the features and functions of your new McIntosh.

Please Take A Moment

The serial number, purchase date and McIntosh Dealer name are important to you for possible insurance claim or future service. The spaces below have been provided for you to record that information:

Serial Number: _____

Purchase Date: _____

Dealer Name: _____

Technical Assistance

If at any time you have questions about your McIntosh product, contact your McIntosh Dealer who is familiar with your McIntosh equipment and any other brands that may be part of your system. If you or your Dealer wish additional help concerning a suspected problem, you can receive technical assistance for all McIntosh products at:

McIntosh Laboratory, Inc.
2 Chambers Street
Binghamton, New York 13903
Phone: 607-723-1545
Fax: 607-724-0549

Customer Service

If it is determined that your McIntosh product is in need of repair, you can return it to your Dealer. You can also return it to the McIntosh Laboratory Service Department. For assistance on factory repair return procedure, contact the McIntosh Service Department at:

McIntosh Laboratory, Inc.
2 Chambers Street
Binghamton, New York 13903
Phone: 607-723-3515
Fax: 607-723-1917

Copyright 2008 © by McIntosh Laboratory, Inc.

Table of Contents

Safety Instructions	2
Thank You and Please Take a Moment.....	3
Technical Assistance and Customer Service	3
Table of Contents and General Information	3
Introduction.....	4
Performance Features	5
Dimensions	6-7
Installation	8
How to Connect using a single Amplifier	9
How to Connect using two Amplifiers.....	10-11
How to Connect using three Amplifiers.....	12-13
Specifications.....	14
Packing Instruction.....	15

General Information

Caution: The XR200 weight is 113 pounds (51.3kg). It requires two or more persons to safely handle the Loudspeaker System.

- Loudspeaker Cables of adequate size are important to ensure that there will be no significant power loss or heating. Cable size is specified in Gauge numbers or AWG (American Wire Gauge). The smaller the Gauge number, the larger the wire size:
*If the Loudspeaker Cables are 50 feet (38.1m) or less, use at least 12 Gauge (AWG) wire size or larger.
If the Loudspeaker Cables are 100 feet (76.2m) or less, use at least 10 Gauge (AWG) wire size or larger.**
- For additional connection information, refer to the owner's manual(s) for any component(s) connected to the XR200 Loudspeaker.*
- The XR200's built-in speaker protection incorporates three automatic resetting solid-state devices in the crossover networks. One protects the tweeters, one for the midranges and one for the woofers. The protection allows a certain amount of overdrive but extended periods will trigger protection. If an obvious lack of high, mid or low frequencies is noticed, the Protection Device may have activated. These devices will automatically reset when the volume level is reduced significantly and kept low until the output of the affected Loudspeaker Element returns to normal.*
- When the XR200 Loudspeaker System is driven by more than one amplifier, the output levels of the different amplifiers connected to the Loudspeaker System must be adjusted to achieve a proper balance between the low, midrange and high frequencies reproduced. This adjustment is best achieved through the use of audio test equipment operated by a qualified installer.*
- When discarding the unit, comply with local rules or regulations. Batteries should never be thrown away or incinerated but disposed of in accordance with the local regulations concerning battery disposal.*
- For additional information on the XR200 and other McIntosh Products please visit the McIntosh Web Site at www.mcintoshlabs.com.*





Introduction

McIntosh Acoustic Engineers have achieved in the design of the XR200 Loudspeaker System a level of high performance. The XR200 provides superior spaciousness sound reproduction with unusual sound stage depth in a full range system. It uses a new acoustic design technology know as Progressive Inductance Control™ (PIC). PIC™ permits the use of multiple Mid-range and Tweeter Loudspeaker Drivers to increase the Dynamic Range of the Loudspeaker System, without the otherwise negative Acoustic Combining Effects present in such a point source Loudspeaker design.

The XR200 utilizes multiple three-quarter inch Titanium Dome Tweeters and two inch Midrange Inverted Titanium Dome Drivers. Refer to figures 1 and 2. Since the audio power is distributed among all the drivers, each driver does not have to work as hard, resulting in greater power handling capability, dramatic reduction in distortion and greater dynamic range.

The Low Frequency Section of the System consists of three newly designed eight inch Woofers. They have a large magnet assembly and long cone excursions with very low levels of harmonic distortion and frequency response down to 20Hz. Refer to figure 3.



Figure 3

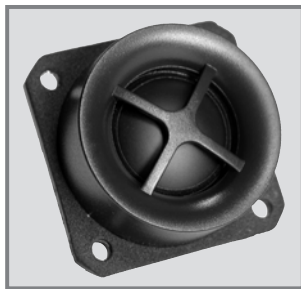

Figure 1



Figure 2

The three Woofers incorporate McIntosh's Patented LD/HP¹ Magnetic Circuit Design. Finite Element Analysis and testing resulted in a design concept which utilizes a pair of aluminum shorting sleeves in the magnetic circuit. Refer to figure 4. The sleeves greatly reduce the negative influence of the fluctuating voice coil field on the permanent magnet field. This results in lower distortion due to more linear magnetic flux in the voice coil gap. Refer to figure 5. Additional benefits are less volume compression due to improved heat transfer through the sleeves and a cooler operating voice coil. Both measurements, as well as critical listening, reveal ten times less distortion than previous designs. A good example of this low distortion is incredible smoothness and clarity in the reproduction of the human voice.



Figure 4

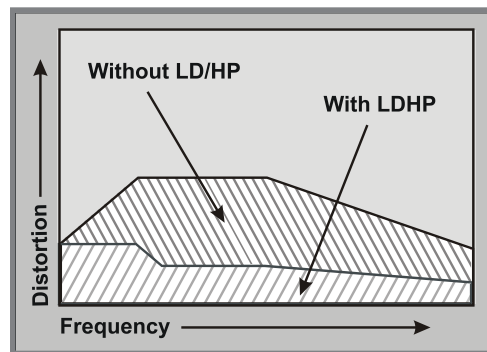

Figure 5

The Crossover Network used in the XR200 Loudspeaker System is designed to ensure an even frequency response over the entire audible range. The Third Order Designed Network utilizes Capacitors and Inductors with high current capacity. Refer to figures 6, 7 and 8. There are two different types of low loss (DCR) Inductors in the network, each one chosen not to exhibit any core saturation even at high power levels. This prevents the addition of distortion to the music at any frequency. The Capacitors used are the low loss (ESR) types. The Network also utilizes self resetting high current PTC Fuses to provide an extra measure of protection.

The enclosure is an important part of the XR200 Loudspeaker System. It has multiple front to back and side to side internal braces to form a dampened rigid Loudspeaker enclosure. The Loudspeaker's small footprint allows for a variety of different placements in a room.

¹LD/HP Pat. No 5,151,943

Performance Features

- **Patented LD/HP® Technology**

The McIntosh Low Frequency Loudspeaker Elements feature the patented LD/HP Magnetic Circuit Design. This design, when compared to conventional Loudspeaker Elements, reduces distortion significantly. It also increases power handling and efficiency.

- **Neodymium-Iron-Boron Alloy Magnets**

The 12 two inch Midranges and 7 three-quarter inch Dome Tweeters all use this Alloy. The Neodymium-Iron-Boron Alloy has the highest flux density per unit of volume. This allows for a smaller physical size driver and thus closer driver to driver placement for improved driver dispersion.

- **Low Harmonic and Intermodulation Distortion**

The XR200 Loudspeaker System is capable of reproducing the full dynamic range of a symphony orchestra with very low audible distortion of any kind.

- **Large Low Frequency Port**

The XR200 Loudspeaker System utilizes a large 4 inch diameter port to increase bass output, reduce distortion and improve the overall efficiency of the Loudspeaker.

- **High Power Handling**

The Loudspeaker Elements and Crossover Components of the XR200 are all chosen for use with amplifiers up to 600 watts.

- **Superior Imaging**

Locating the Tweeters between the two rows of Midranges generates a symmetrical horizontal polar response for superior imaging.

- **Versatile Operation and Placement**

In addition to the regular connections, the XR200 Loudspeaker System provides separate connections for Bi-Amplification and Tri-Amplification hookups, as well as Bi-Wiring and Tri-Wiring.

- **Loudspeaker Enclosure**

The XR200 Loudspeaker enclosure is constructed with non-parallel internal sides to reduce internal standing waves and is given a High Gloss Black Piano Type Finish.

- **Gold Plated Input Connectors**

The XR200 input connectors are gold plated for superior corrosion resistance and high electrical conductivity.

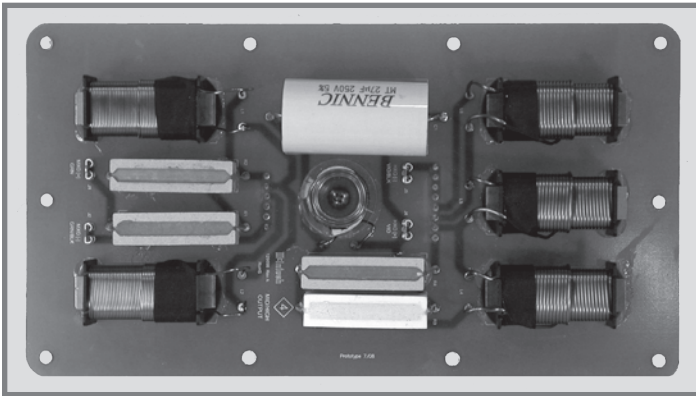

Figure 6

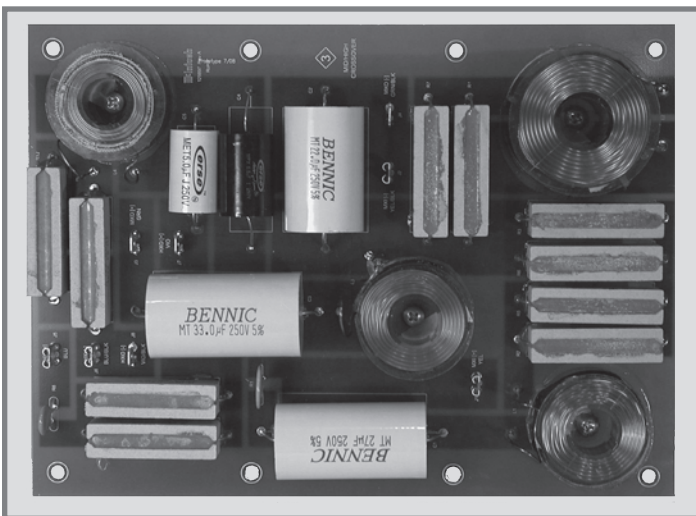

Figure 7

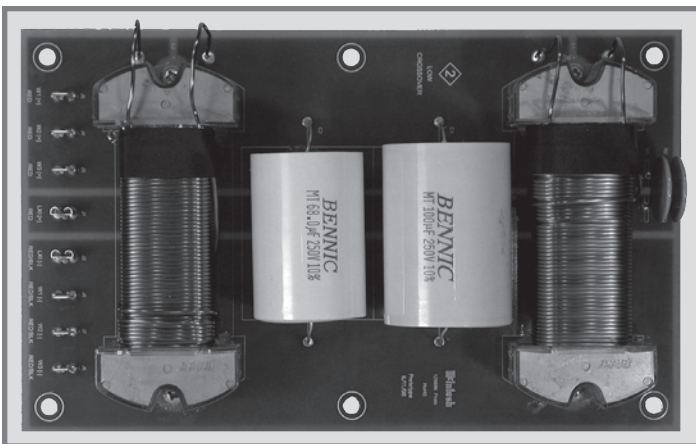
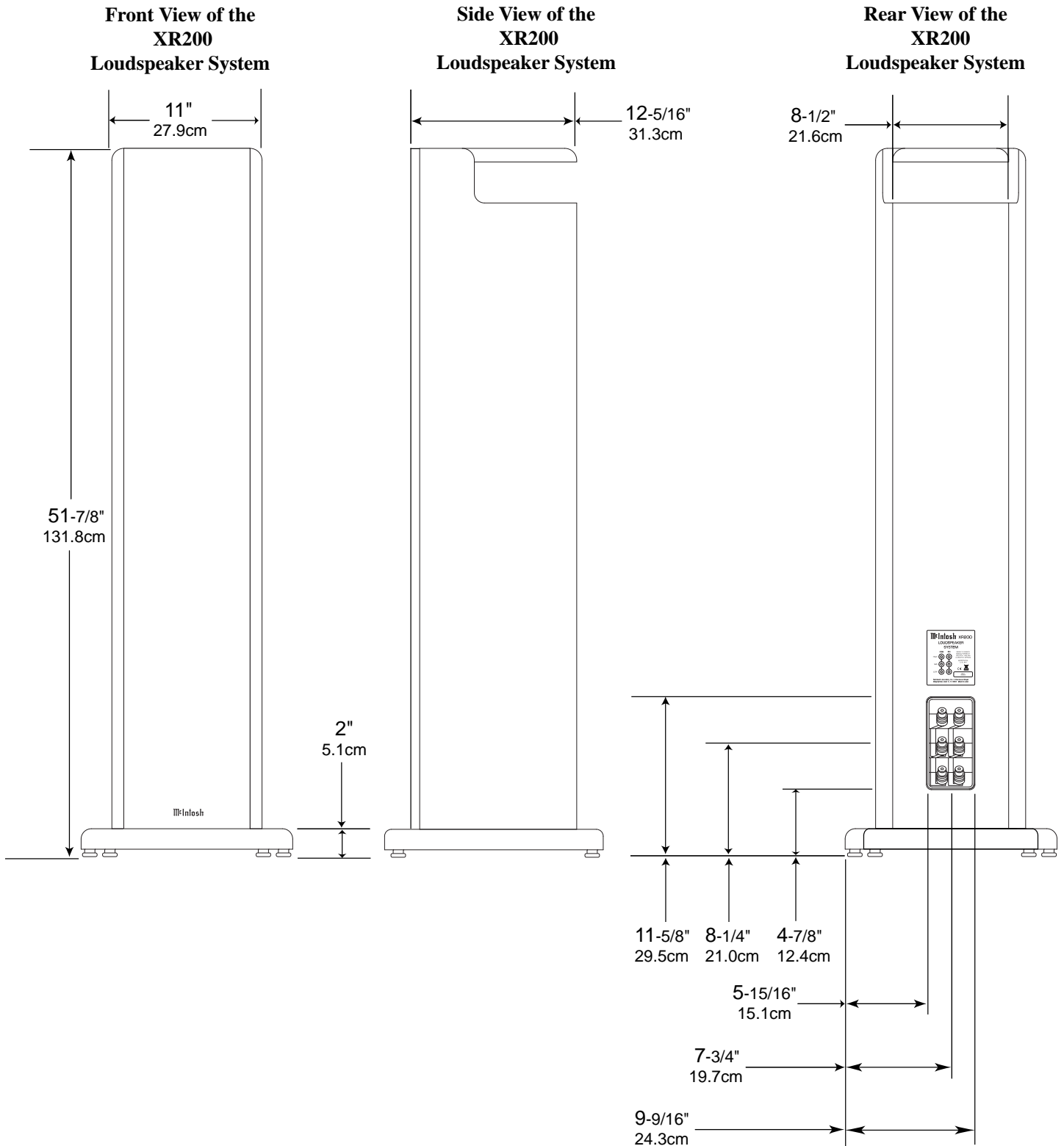

Figure 8



Dimensions

The following dimensions can assist in determining the best location for your XR200 Loudspeaker System.



**Front View of the
XR200
Loudspeaker System**

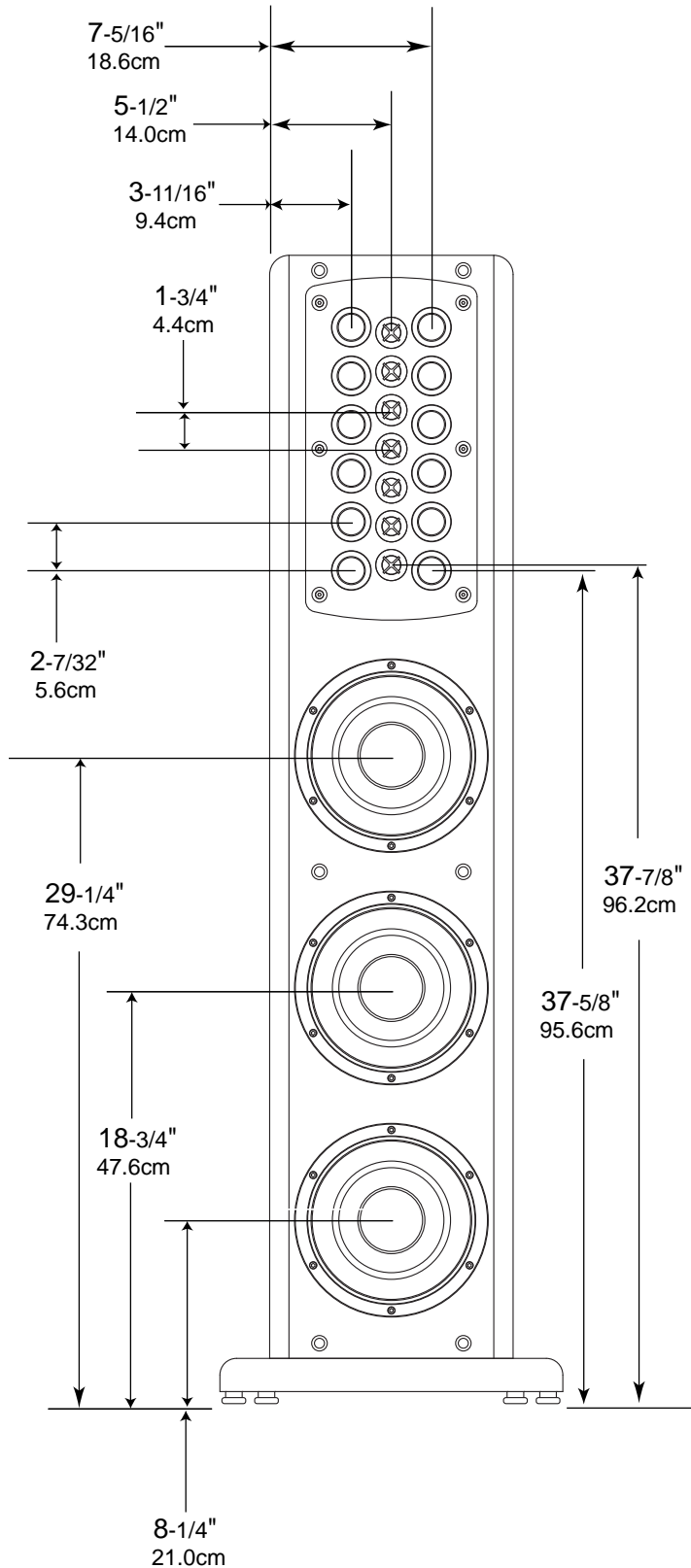

**Top End View of the
XR200
Loudspeaker System**

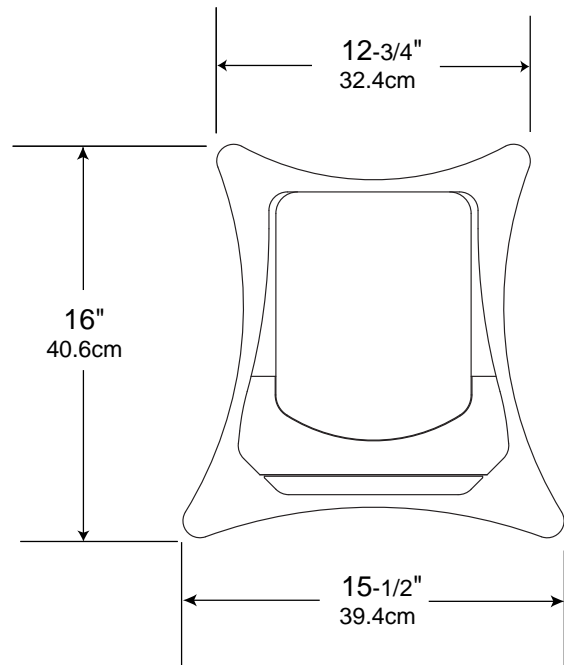

Note: If the base is removed for custom installation use four, 1/4-20 3/4inch screws to plug the openings.

Installation

Loudspeaker Placement

Loudspeaker placement in a room can greatly affect performance. The XR200 Loudspeaker is designed for both Music and Home Theater Systems. The optimal method for selecting speaker locations includes the use of a real time spectrum analyzer operated by an experienced system installer. An uncompromising installation would take into consideration the floor, wall and ceiling coverings, the type and placement of furniture and can even include the architectural design of the room and its construction materials. In those instances where placement in the room is fixed, an environmental equalizer may be needed to restore proper musical balance.

Placement near a wall, corner, floor, ceiling or any intersecting surfaces will reinforce or diminish some bass frequencies. The bass frequencies that are altered by placement in a particular location is dependent on the dimensions of the room. If professional measurement equipment is not available, listen to the Loudspeaker. Try various locations by listening to music containing continuous bass and finding a location where there is an over all musical balance in the sound and the bass content does not predominate.

The XR200's Smooth Frequency Response may be altered by a large object(s) located in the sound waves path or by locating the Loudspeaker too close to a side wall. There should be an unobstructed area in front of the Loudspeaker of at least 30 degrees either side from the center axis for the best performance. Refer to figure 1.

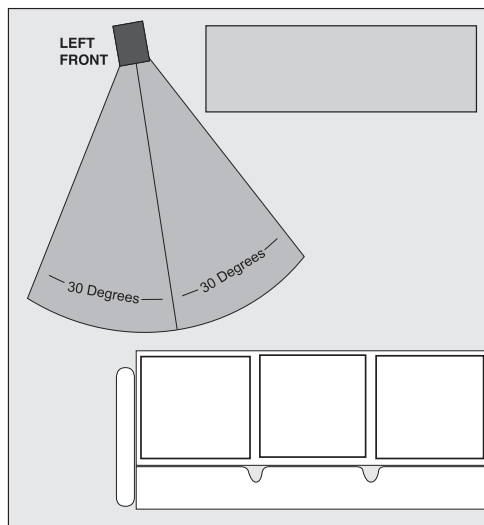

Figure 1

Locating Loudspeakers for use in Home Theater

In a Home Theater application, the placement of Left and Right Front Loudspeakers can be limited by such considerations as the size and location of the video monitor. The locating suggestions in the “for use in a Music System” section below can still be helpful as a starting place. Refer to figure 2.

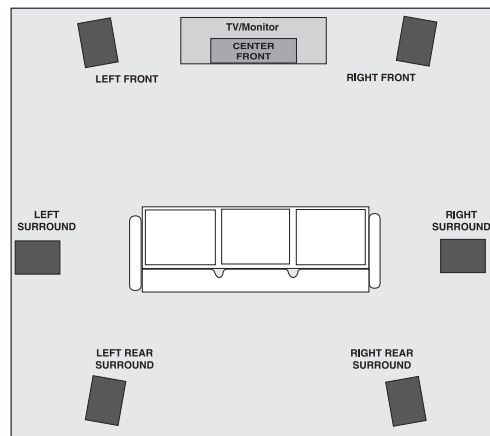

Figure 2

Locating Loudspeakers for use in a Music System

When used in a Music System the distance between the Loudspeakers and the listener to the Loudspeakers should form an equilateral or an acute isosceles triangle. If the speakers are too far apart relative to the listener, some imaging can be lost. Refer to figure 3.

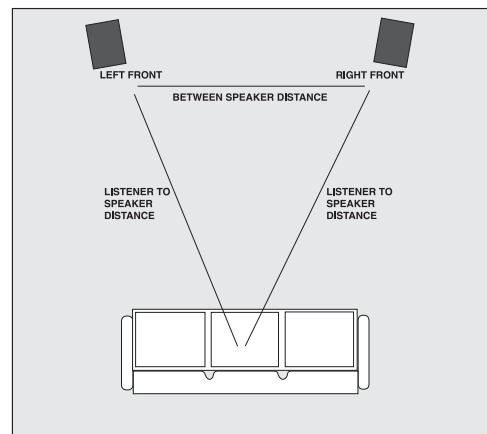

Figure 3

Unpacking the Loudspeaker

To protect the fine finish of the XR200 Loudspeaker System during the installation process, it is advisable to prepare a suitable adjustment area. A freshly vacuumed carpeted area covered with a soft, clean fabric, such as a large bed linen or blanket would be suitable.

It is recommended that the Professionals at your McIntosh Dealer, who are skilled in all aspects of installation and operation, install the XR200 Loudspeaker System and any associated audio equipment.

CAUTION: This Loudspeaker weighs 113 pounds (51.3 kgs). It requires two or more persons to safely handle the Loudspeaker.

How to Connect using a single Amplifier

Caution: The AC Power Cord should not be connected to the Power Amplifier until after the Loudspeaker Connections have been made. Failure to observe this could result in Electric Shock.

1. Prepare Loudspeaker cables by choosing one of the methods below:

Bare wire cable ends:

Carefully remove sufficient insulation from the cable ends, refer to figures 9, 10 & 11. If the cable is stranded, carefully twist the strands together as tightly as possible.

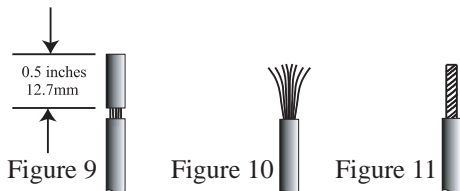

Note: If desired, the twisted ends can be tinned with solder to keep the strands together or attach spade lugs.

Spade lug or prepared wire connection:

Insert the spade lug connector or prepared section of the cable end into the terminal side access hole, and tighten the terminal cap until the cable is firmly clamped into the terminal so the wires cannot slip out. Refer to figures 12, 13 & 14.

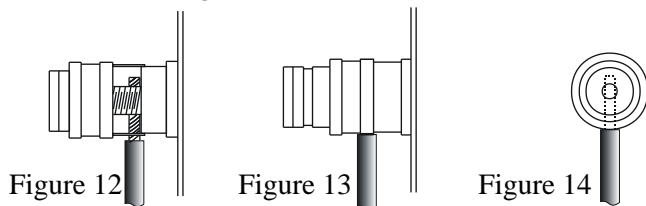

2. Connect a Loudspeaker cable from the XR200 LOW Frequency COM Binding Post to the Left Channel COM (-) Binding Post of the Power Amplifier.
 - Notes:* 1. It is important to maintain the correct polarity at both ends of the Loudspeaker cables.
 - 2. For proper operation the metal jumpers must be installed between the Loudspeaker Terminal Posts as illustrated.
3. Connect a Loudspeaker cable from the XR200 LOW Frequency 8Ω Binding Post to the Left Channel 8 ohm (+) Binding Post of the Power Amplifier.
4. In a similar manner, connect the second XR200 Loudspeaker to the Power Amplifier Right Channel Binding Posts.
4. Tighten all of the Loudspeaker and Amplifier Binding Posts.

McIntosh Power Amplifier

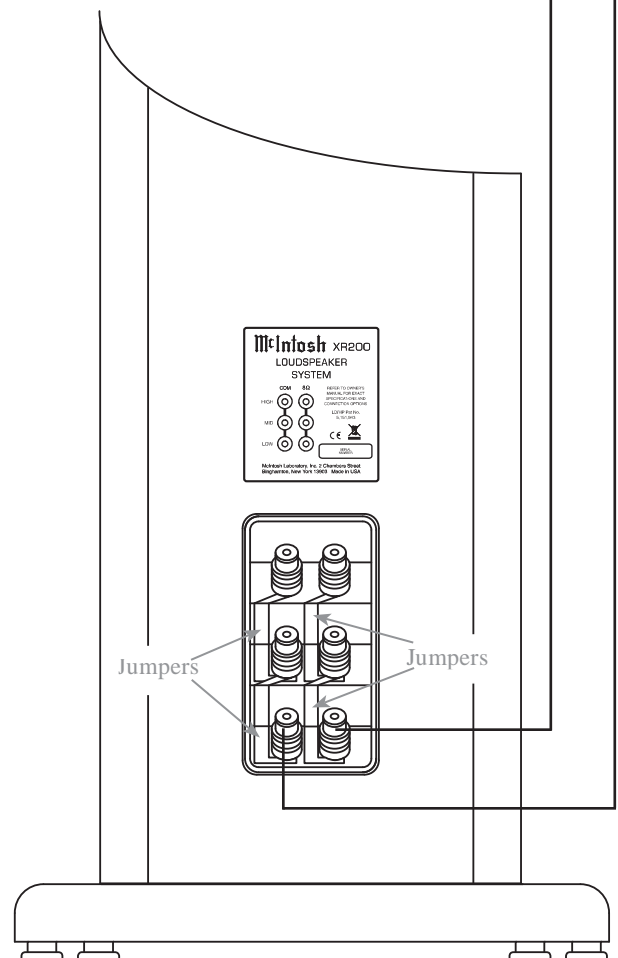
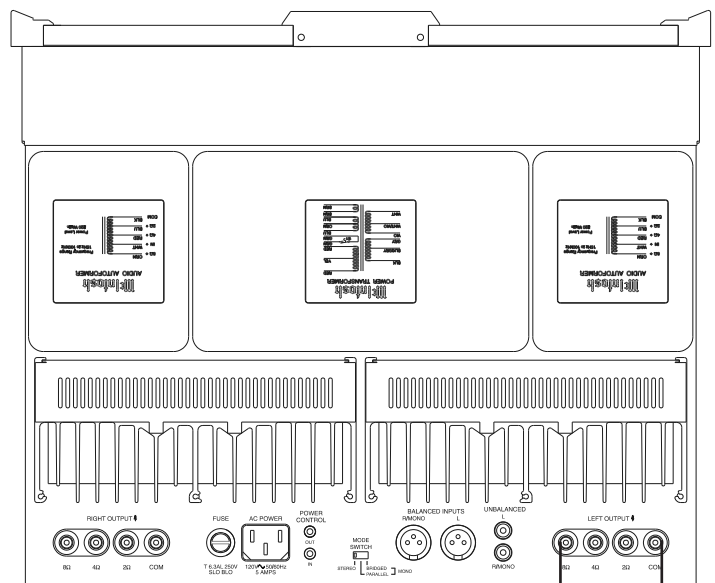



How to Connect using two Amplifiers

Caution: The AC Power Cord should not be connected to the Power Amplifier until after the Loudspeaker Connections have been made. Failure to observe this could result in Electric Shock.

1. Prepare Loudspeaker cables by choosing one of the methods below:

Bare wire cable ends:

Carefully remove sufficient insulation from the cable ends, refer to figures 9, 10 & 11. If the cable is stranded, carefully twist the strands together as tightly as possible.

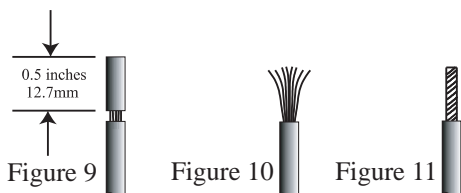

Note: If desired, the twisted ends can be tinned with solder to keep the strands together or attach spade lugs.

Spade lug or prepared wire connection:

Insert the spade lug connector or prepared section of the cable end into the terminal side access hole, and tighten the terminal cap until the cable is firmly clamped into the terminal so the wires cannot slip out. Refer to figures 12, 13 & 14.

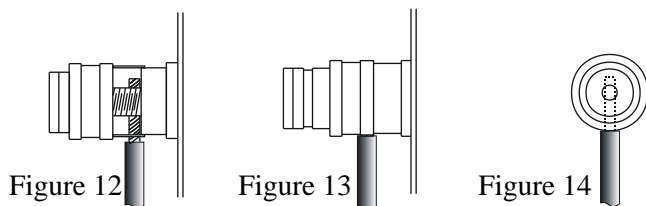

2. Remove the metal jumper between the Loudspeaker LOW Frequency COM (-) Binding Post and MID Frequency COM (-) Binding Post.
3. Remove the metal jumper between the Loudspeaker LOW Frequency 8Ω (+) Binding Post and MID Frequency 8Ω (+) Binding Post.
4. Connect a Loudspeaker cable from the XR200 LOW Frequency COM Binding Post to the COM (-) Binding Post of the Power Amplifier number One.

Notes: 1. It is important to maintain the correct polarity at both ends of the Loudspeaker cables.

2. For proper operation the metal jumpers must be installed between the Loudspeaker Terminal Posts as illustrated.

5. Connect a Loudspeaker cable from the XR200 LOW Frequency 8Ω Binding Post to the 8 ohm (+) Binding Post of the Power Amplifier number One.
6. Connect a Loudspeaker cable from the XR200 MID Frequency COM Binding Post to the COM (-) Binding Post of the Power Amplifier number Two.
7. Connect a Loudspeaker cable from the XR200 MID Frequency 8Ω Binding Post to the 8 ohm (+) Binding Post of the Power Amplifier number Two.
8. Tighten all of the Loudspeaker and Amplifier Binding Posts.

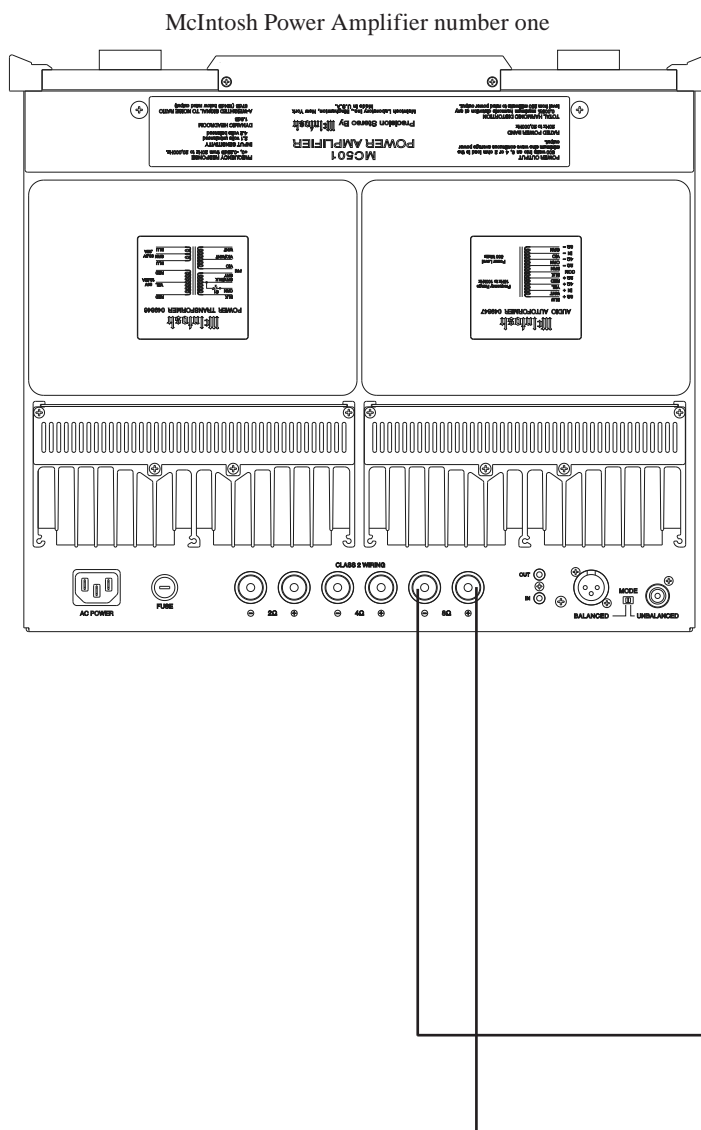

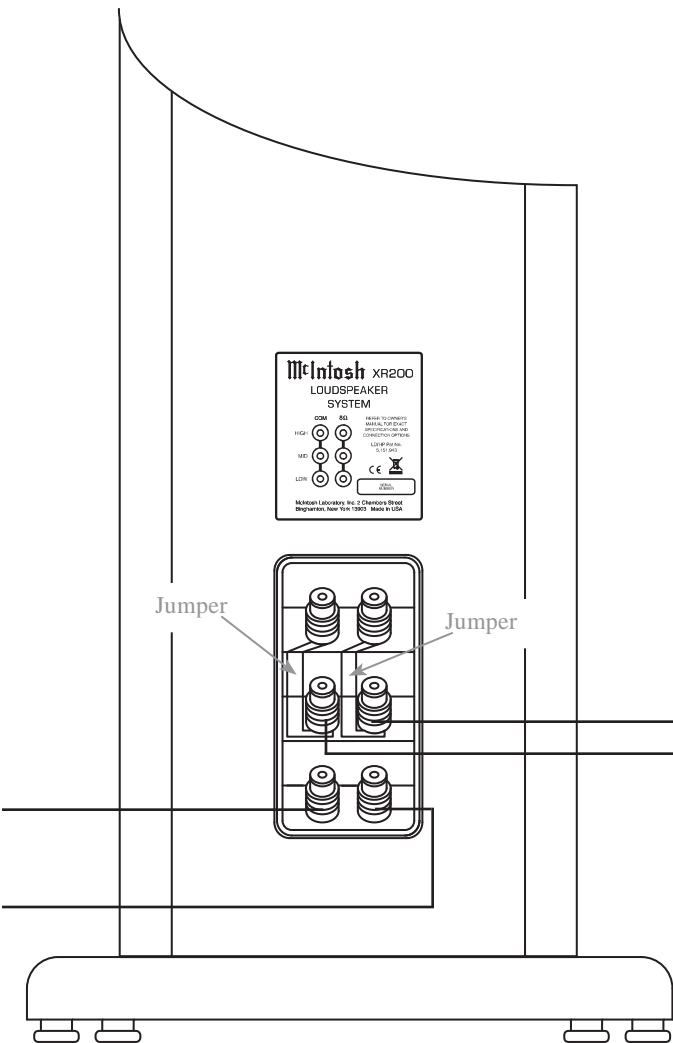
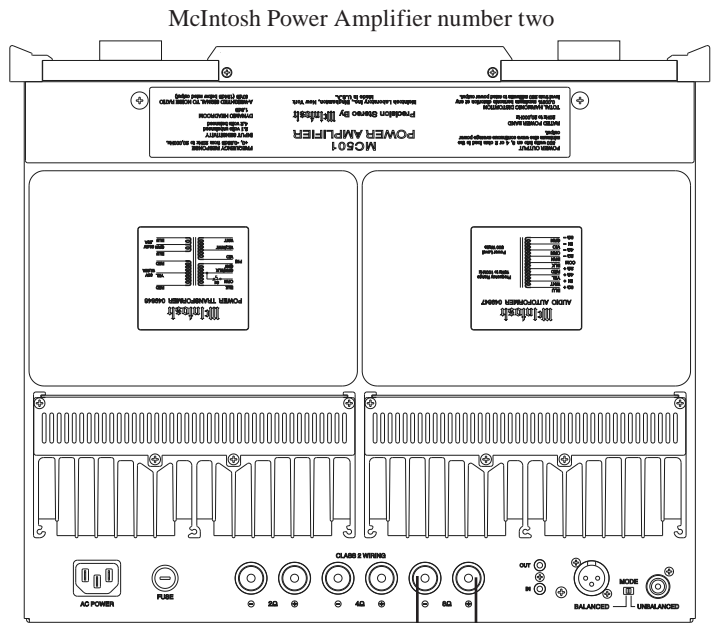

How to Connect using three Amplifiers

Caution: *The AC Power Cord should not be connected to the Power Amplifier until after the Loudspeaker Connections have been made. Failure to observe this could result in Electric Shock.*

1. Prepare Loudspeaker cables by choosing one of the methods below:

Bare wire cable ends:

Carefully remove sufficient insulation from the cable ends, refer to figures 9, 10 & 11. If the cable is stranded, carefully twist the strands together as tightly as possible.

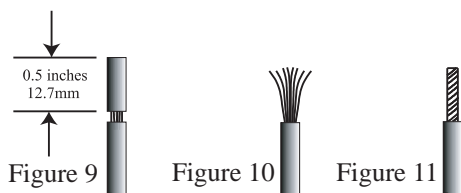

Note: If desired, the twisted ends can be tinned with solder to keep the strands together or attach spade lugs.

Spade lug or prepared wire connection:

Insert the spade lug connector or prepared section of the cable end into the terminal side access hole, and tighten the terminal cap until the cable is firmly clamped into the terminal so the wires cannot slip out. Refer to figures 12, 13 & 14.

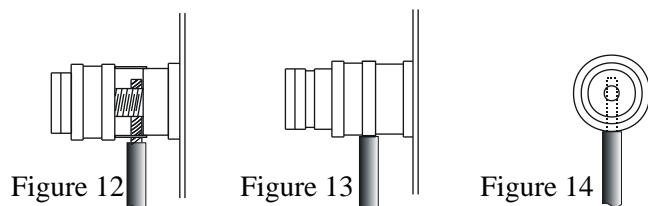

2. Remove all four metal jumpers between Loudspeaker Binding Posts.
4. Connect a Loudspeaker cable from the XR200 LOW Frequency COM Binding Post to the COM (-) Binding Post of the Power Amplifier Output One.
Note: It is important to maintain the correct polarity at both ends of the Loudspeaker cables.
5. Connect a Loudspeaker cable from the XR200 LOW Frequency 8Ω Binding Post to the 8 ohm (+) Binding Post of the Power Amplifier Output One.
6. Connect a Loudspeaker cable from the XR200 MID Frequency COM Binding Post to the COM (-) Binding Post of the Power Amplifier Output Two.
7. Connect a Loudspeaker cable from the XR200 MID Frequency 8Ω Binding Post to the 8 ohm (+) Binding Post of the Power Amplifier Output Two.

8. Connect a Loudspeaker cable from the XR200 HIGH Frequency COM Binding Post to the COM (-) Binding Post of the Power Amplifier Output Three.
9. Connect a Loudspeaker cable from the XR200 HIGH Frequency 8Ω Binding Post to the 8 ohm (+) Binding Post of the Power Amplifier Output Three.
10. Tighten all of the Loudspeaker and Amplifier Binding Posts.

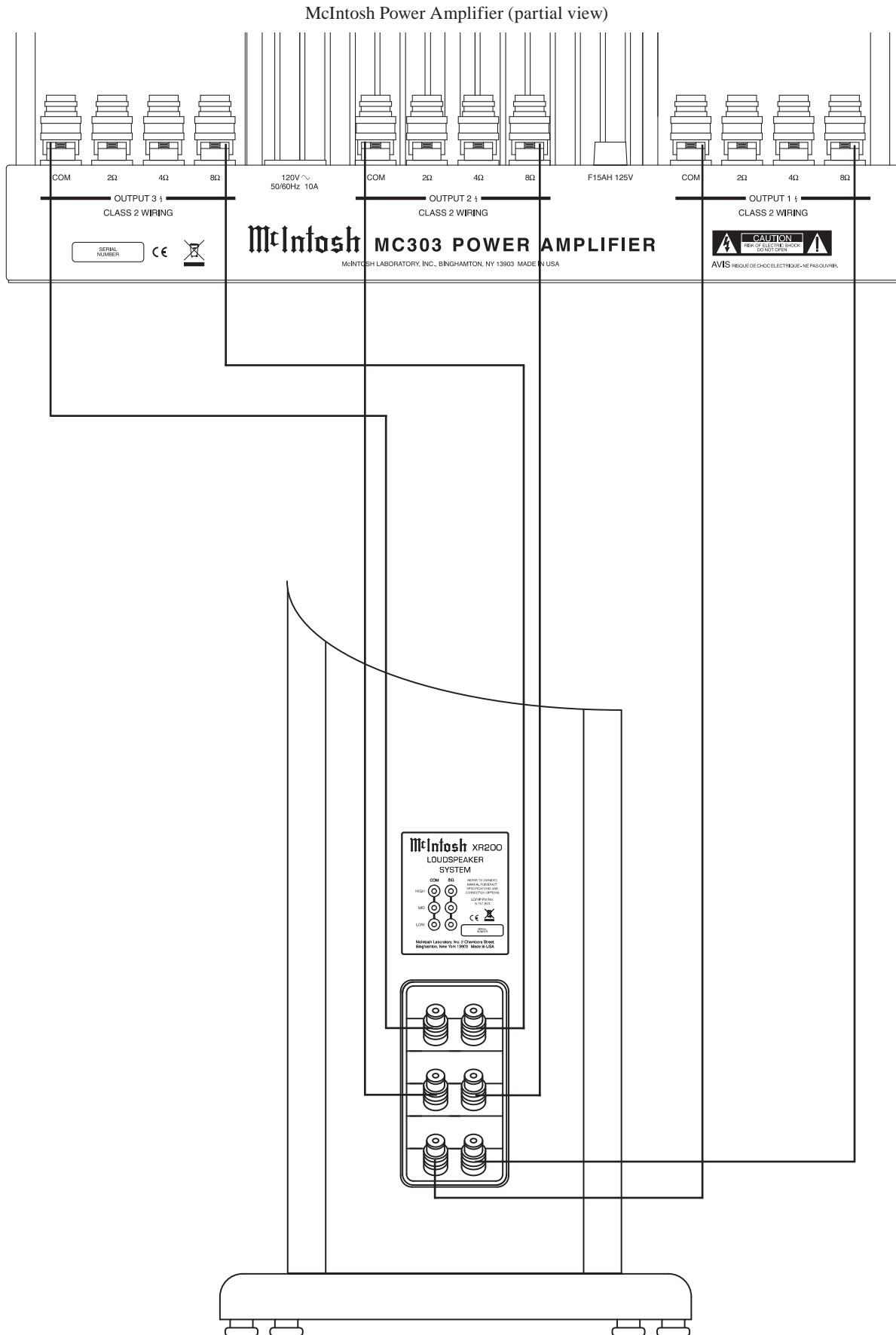



Specifications

System Driver Complement

Three 8 inch LD/HP® Woofers
Twelve 2 inch Titanium Inverted
Dome Midranges
Seven 3/4 inch Titanium Dome Tweeters

Impedance

8 ohms Nominal

Frequency Response

20Hz - 45kHz

Sensitivity

86dB (2.83V/1m equivalent)

Crossover Frequencies

240Hz
1,900Hz

Power Handling

600 Watts Maximum

General Specifications

Finish Enclosure

High Gloss Black

Finish Grille

Black Knit Cloth

Overall Dimensions (includes base and feet)

Height is 51-7/8 inches (131.8cm)
Width is 15-1/2 inches (39.4cm)
Depth is 16 inches (40.6cm)

Weight

113 pounds (51.3 kg) net
137 pounds (62.3kg) in shipping carton

Shipping Carton Dimensions

Width is 57-9/16 inches (146.20cm)
Depth is 24 inches (60.96cm)
Height is 21-11/16 inches (55.10cm)

Packing Instructions

In the event it is necessary to repack the equipment for shipment, the equipment must be packed exactly as shown below. To protect the finish of the Loudspeaker it is advisable to place it in the original protective cotton blue cover before placing it into the shipping carton.

Use the original shipping carton and interior parts only if they are all in good serviceable condition. If a shipping carton or any of the interior part(s) are needed, please call or write Customer Service Department of McIntosh Laboratory. Please see the Part List for the correct part numbers.

Quantity	Part Number	Description
1	034448	Top shipping carton
1	034449	Bottom shipping carton
1	034450	Top end foam cap
1	034451	Bottom end foam cap
1	034452	Center support foam
1	034462	Blue Protective cloth cover

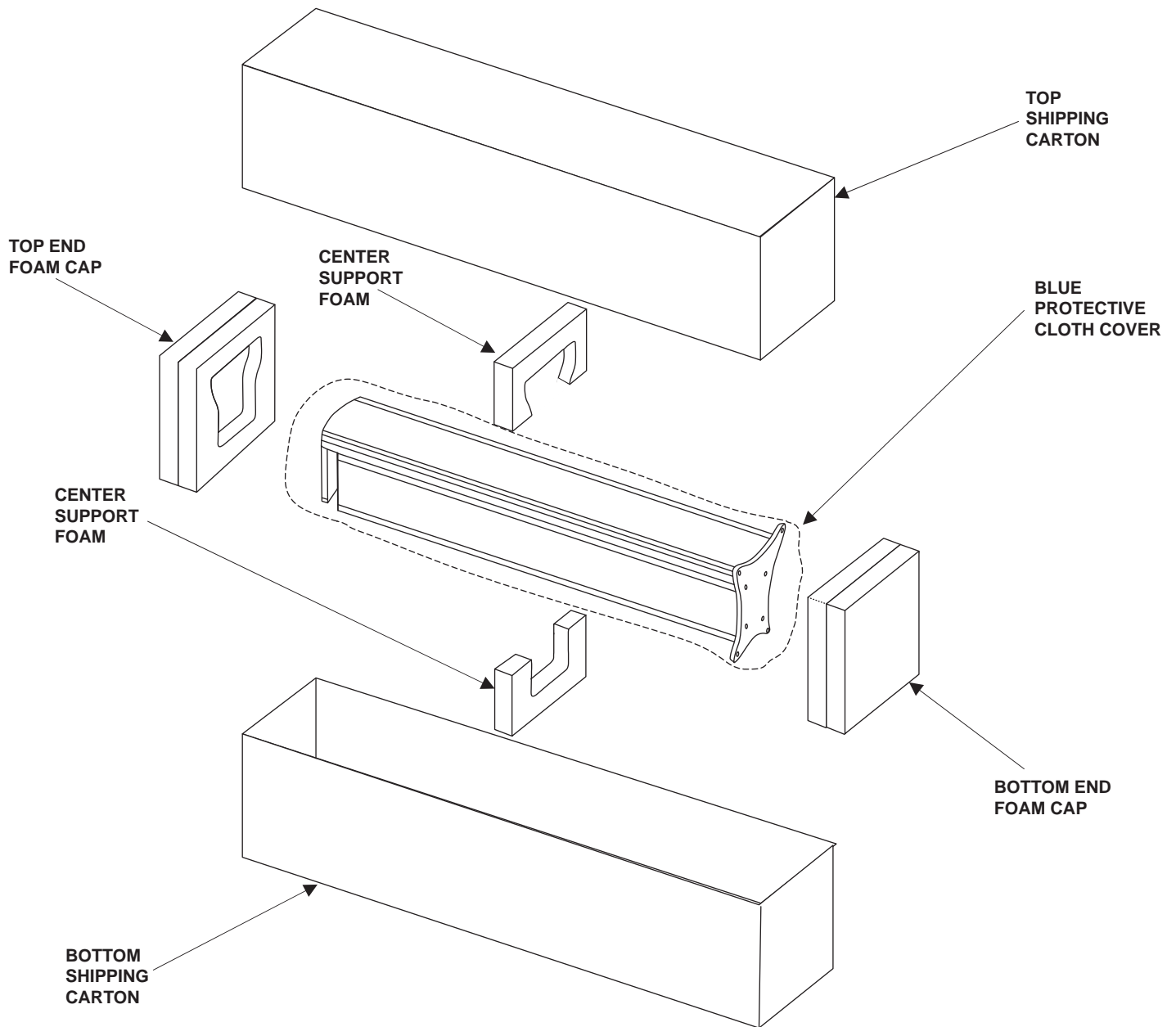



McIntosh Laboratory, Inc.
2 Chambers Street
Binghamton, NY 13903
www.mcintoshlabs.com

The continuous improvement of its products is the policy of McIntosh Laboratory Incorporated who reserve the right to improve design without notice. Printed in the U.S.A.